

Specification sheet

REV.2

CLASSIC 75 AJ GEN 2, Square 3 " Architectural Downlight

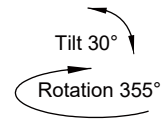
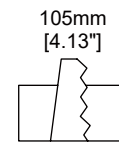
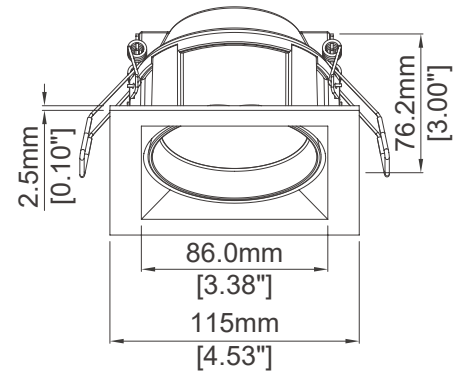

Description

Classic 75 AJ is a versatile gimbal-adjustable recessed downlight with integrated dimmable class 2 driver. The die-cast LED engine and trim construction presents a sharp and sleek look. This luminaire features functional adjustability, 30° tilt and 355° rotation, and options for four different beam angles. Classic 75 AJ comes with 5 year warranty and it is one of the best value downlights we offer.

Features

LED	Lumiled Luxeon COB1203
Color temperature	2700K/ 3000K/ 3500K/ 4000K
Optics	Spot 20° / Medium 31° / Wide 41° / Flood 91°
Driver	Remote Class 2 driver, power factor >0.90

Performance

Delivered output	Up to 850 lm(90+ CRI)
Power consumption	9 W
Color consistency	3SDCM
Color rendering	90+CRI
CBCP	Spot 3537 cd / Medium 2230 cd / Wide 1491 cd / Flood 402 cd
Lumen Maintenance	L80 B10 50,000 Hours

Electrical and Control

Input voltage	See the ordering code
Control	TRIAC / ELV
Feature	Overload & short circuit protection.

Construction

Material	Die-Cast Aluminum
Finishes	White / Black
Optics	Field Interchangeable optics

Rating/ Certification/ Warranty

- Dry and damp Locations
- RoHS compliant
- 5 years/ 50,000 hrs warranty

Ordering Code Information

PRODUCT	SHAPE	COLOR TEMPERATURE	FINISH	BEAM ANGLE	COLOR RENDERING
CLS75AJ	S	27	WH	S	9
CLS75 AJ SQ	S Square	27 (2700K) 30 (3000K) 35 (3500K) 40 (4000K)	WH (White) BK (Black)	S (Spot) / 20 deg. M (Medium) / 31 deg. W (Wide) / 41 deg. F (Flood) / 91 deg.	9 (90 CRI+)

Specification sheet

REV.2

CLASSIC 75 AJ GEN 2, Square

3 " Architectural Downlight

Photometrics

9W | 90CRI | 3000K | Square

MULTIPLYING FACTORS: (Multiplying Factor is based on 3000K-90+CRI IES file on website)

CCT	2700K-80+	3000K-80+	3500K-80+	4000K-80+
Factors	1.16	1.19	1.22	1.26

CCT	2700K-90+	3000K-90+	3500K-90+	4000K-90+
Factors	0.97	1.0	1.05	1.08

Spot 20°

Delivered Ourput : 841 lm | CBCP : 3537 cd | Beam Angle : 20°

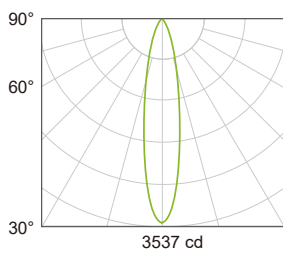

Center Beam Intensity	Beam Width	Height
3537 lx	35cm	1m
884 lx	70cm	2m
393 lx	105cm	3m
221 lx	140cm	4m
141 lx	175cm	5m

Medium 31°

Delivered Ourput : 838 lm | CBCP : 2230 cd | Beam Angle : 31°

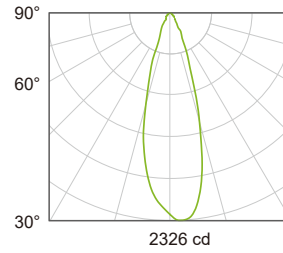

Center Beam Intensity	Beam Width	Height
2309 lx	56cm	1m
577 lx	112cm	2m
256 lx	168cm	3m
144 lx	223cm	4m
92 lx	279cm	5m

Wide 41°

Delivered Ourput : 833 lm | CBCP : 1491 cd | Beam Angle : 41°

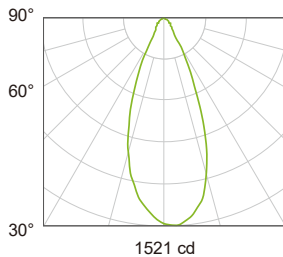

Center Beam Intensity	Beam Width	Height
1515 lx	76cm	1m
379 lx	151cm	2m
168 lx	227cm	3m
95 lx	303cm	4m
61 lx	379cm	5m

Flood 91°

Delivered Ourput : 834 lm | CBCP : 402 cd | Beam Angle : 91°

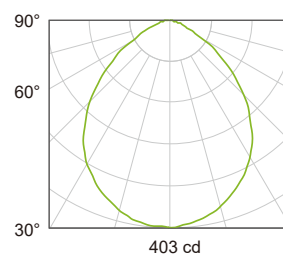

Center Beam Intensity	Beam Width	Height
403 lx	206cm	1m
101 lx	412cm	2m
45 lx	618cm	3m
25 lx	824cm	4m
16 lx	1029cm	5m

Recommend LED Driver:

Driver No.	Input Voltage	Dimming	Note
DAE-3-400-18	120-277V	TRIAC/ELV/0-10V	